



EBARA

DWO

OPEN IMPELLER CENTRIFUGAL ELECTRIC PUMPS

60 Hz



OPEN IMPELLER CENTRIFUGAL ELECTRIC PUMPS

in AISI 304

Open impeller centrifugal electric pumps in AISI 304 stainless steel.



(according to ISO 9906 Attachment A)

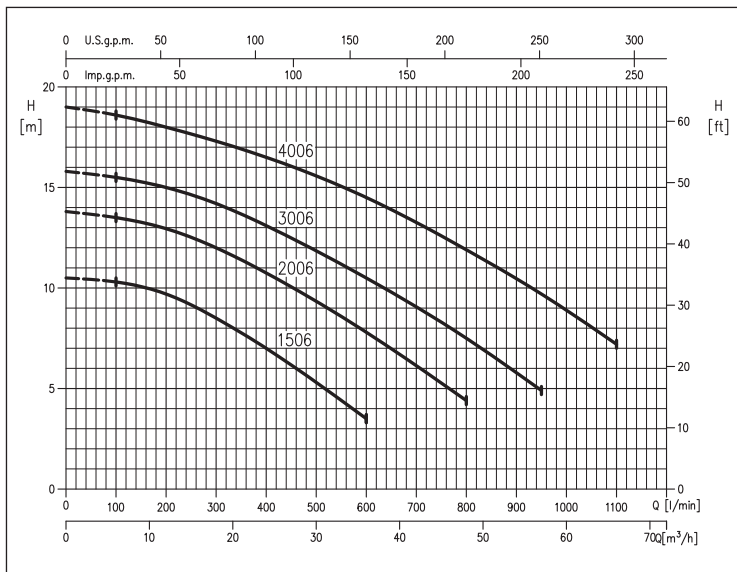

-
-
-
-

-
-
-

- : 8bar
- : +90°C
- H-HS-HW +110°C
- 가 : 9mm
- 2
- F
- IP55
- 220-230V ± 6%, 60Hz
- 220/380V -6 +10% 60Hz
- : DWO3006~4006 - G2½ , G2
- : G2

- Pump body, seal housing disc, impeller and shaft in AISI 304
- Support and motor casing in aluminium
- Mechanical seal in: Ceramic/Carbon/NBR (standard)
 - Ceramic/Carbon/FPM (H version)
 - SiC/SiC/FPM (HS version)
 - Tungsten carbide/Tungsten carbide/FPM (HW version)

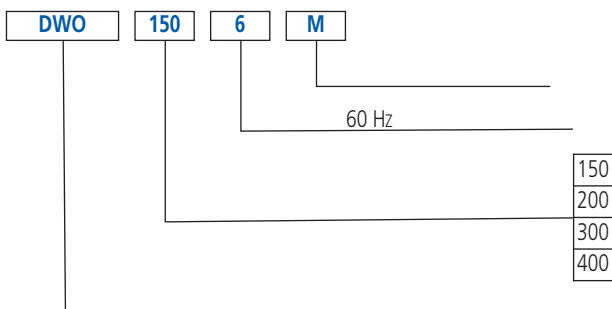

OPEN IMPELLER CENTRIFUGAL ELECTRIC PUMPS

in AISI 304

220-230V	220/380V	P ₂		l/min m ³ /h	Q=							
		[HP]	[kW]		100	200	300	400	600	800	950	1100
DWO 1506 M	DWO 1506	1,5	1,1	10,3	9,7	8,5	7,0	3,5	-	-	-	-
DWO 2006 M	DWO 2006	2	1,5	13,5	12,9	12,0	10,7	7,8	4,4	-	-	-
-	DWO 3006	3	2,2	15,5	15,0	14,2	13,1	10,5	7,5	4,9	-	-
-	DWO 4006	4	3	18,6	18,0	17,3	16,5	14,5	11,9	9,7	7,2	-

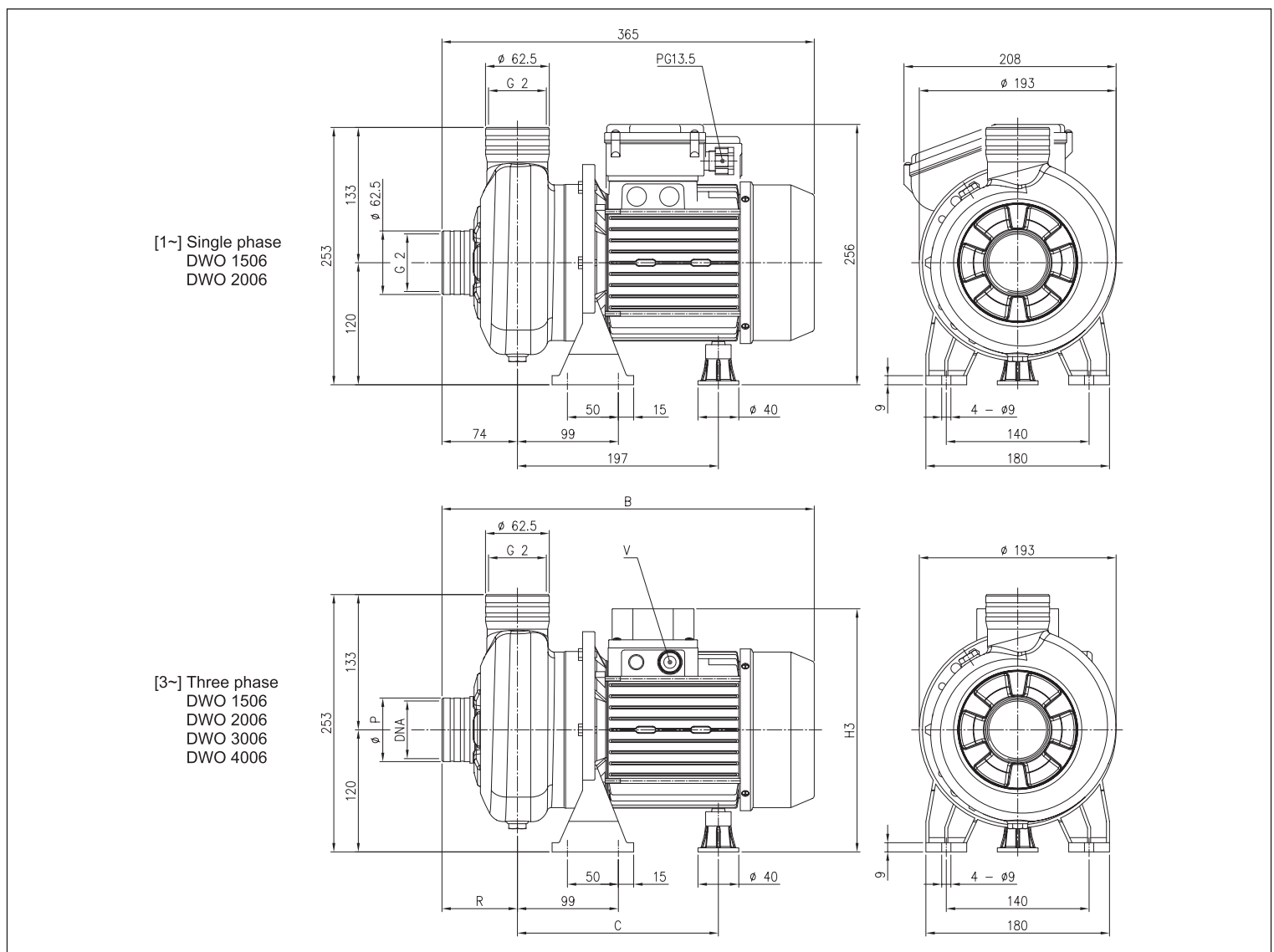

	B [1]	C [1]	H3 [1]	R [1]	P [1]	V [1]	DNA [1]	[2]	[kg]	[1]
DWO 1506	365	197	239	74	62,5	PG11	G2	13,6		14,6
DWO 2006	378	197	239	74	62,5	PG11	G2	15,7		16,4
DWO 3006	416	230±241	244	78	80	PG13,5	G2½	-		19,2
DWO 4006	455	230±241	244	78	80	PG13,5	G2½	-		22,3

[1]= Three phase only
[2]= Single phase only

OPEN IMPELLER CENTRIFUGAL ELECTRIC PUMPS

in AISI 304

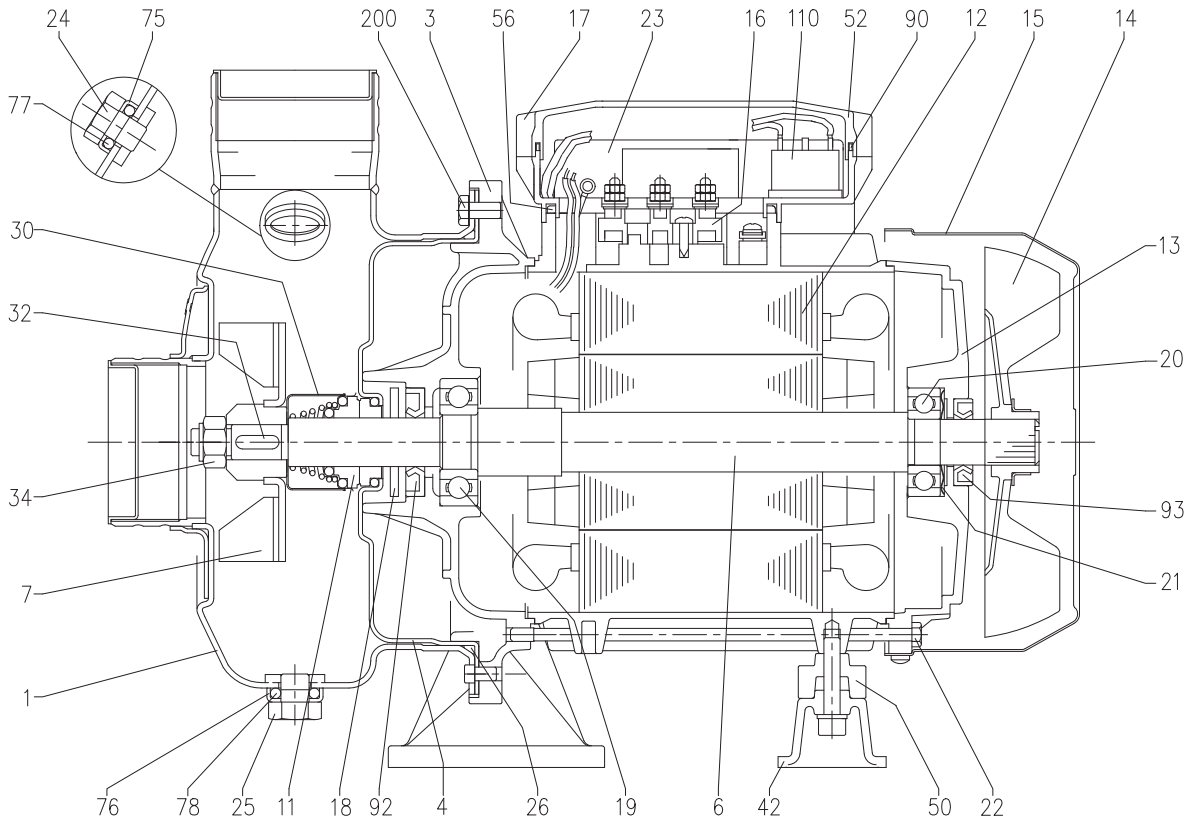

Ref.		Ref.	
1	Pump body	25	Drain plug
3	Motor support	26	O-Ring
4	Seal housing disc	30	Spray protector washer
6	Shaft	32	Key
7	Impeller	34	Impeller nut
11	Mechanical seal	42	Foot
12	Motor case	50	Foot spacer
13	Motor cover	52	Capacitor-holder box [2]
14	Fan	56	Terminal box cover gasket
15	Fan cover	75	Washer
16	Terminal box	76	Washer
17	Terminal box cover [1]	77	O-Ring
18	Spray protector ring	78	O-Ring
19	Bearing (pump side)	90	Terminal box cover box gasket [2]
20	Bearing (motor side)	92	Sealing ring
21	Adjusting ring	93	Sealing ring
22	Tie-rod	110	Motorprotector [2]
23	Capacitor [2]	200	Screw (pump body)
24	Filler cap		

[1]= Three phase only
[2]= Single phase only

OPEN IMPELLER CENTRIFUGAL ELECTRIC PUMPS

in AISI 304

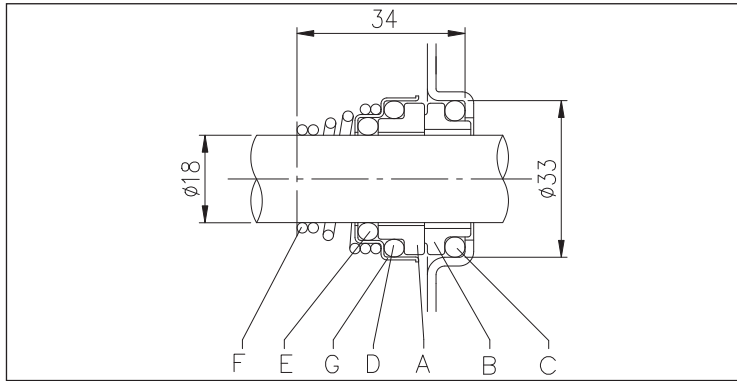

Ref.		
A	Rotating part	Ceramic
B	Fixed part	Carbon
C	O-Ring	NBR
D	O-Ring	NBR
E	O-Ring	NBR
F	Spring	AISI 316
G	Structure/frame	AISI 304

(on request)

	H version	HS version	HW version
Fixed Part	Carbon	SiC	Tungsten Carbide
Rotating Part	Ceramic	SiC	Tungsten Carbide
Elastomers	FPM	FPM	FPM
Spring	AISI 316	AISI 316	AISI 316
Structure/Frame	AISI 304	AISI 316	AISI 316

220-230V	220/380V	P ₂		Capacitor		P ₁		Absorbed Current [A]		
		[HP]	[kW]	μF	V _c	[kW]	[kW]	220-230V	220V	380V
DWO 1506 M	DWO 1506	1,5	1,1	35	450	1,5	2	7,2	5,7	3,3
DWO 2006 M	DWO 2006	2	1,5	35	450	2,06	2,9	9,8	8,1	4,7
-	DWO 3006	3	2,2	-	-	-	2,9	-	7,0	4,1
-	DWO 4006	4	3	-	-	-	3,9	-	10,5	6,1



EBARA

